

● Description

The KPC354 series of devices each consist of two infrared emitting diodes, connected in inverse parallel, optically coupled to a phototransistor detector. They are packaged in a 4-pin Mini-Flat package. The input-output Isolation voltage is rated at 3750 Vrms..

● Schematic

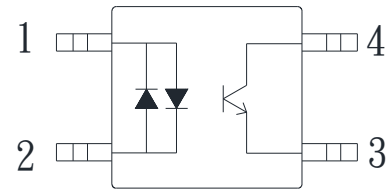

1. Anode/Cathode
2. Anode/Cathode
3. Emitter
4. Collector

● Features

1. Halogen free
2. Pb free and RoHS compliant
3. AC input
4. Mini-flat package: compact 4 pin SOP with a 2.0mm profile
5. Subminiature type (The volume is smaller than that of our conventional DIP type by as far as 30%)
6. Isolation voltage between input and output (Viso : 3750vrms).
7. MSL class 1
8. Agency Approvals:
 - UL Approved (No. E169586): UL1577
 - c-UL Approved (No. E169586)
 - VDE Approved (No. 40014684): DIN EN 60747-5-5
 - FIMKO Approved: EN60065, EN60950
 - CQC Approved: GB8898-2011, GB4943.1-2011

● Applications

- Hybrid substrates that require high density mounting
- Programmable controllers

● **Outside Dimension**

Unit : mm

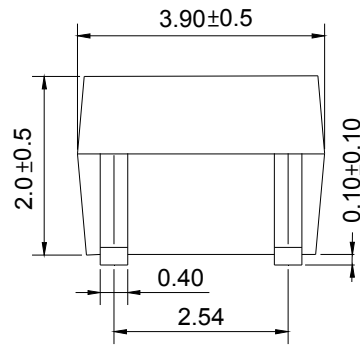
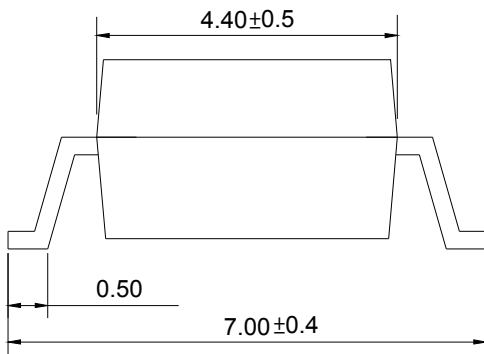
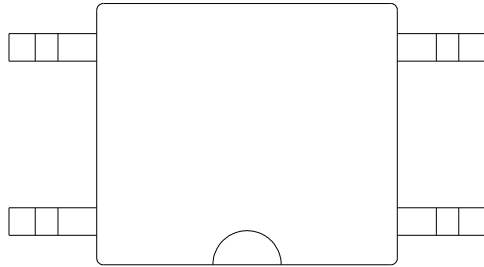

TOLERANCE : ±0.2mm

● **Device Marking**

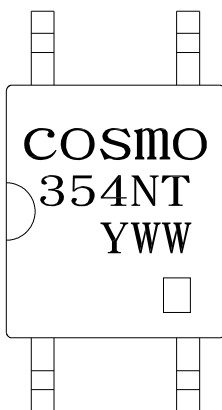

Notes:

Cosmo

354NT

YWW

Y: Year code / WW: Week code



□: CTR rank

● Absolute Maximum Ratings

(Ta=25°C)

Parameter		Symbol	Rating	Unit
Input	Forward current	I_F	± 50	mA
	Peak forward current	I_{FM}	± 1	A
	Power dissipation	P_D	70	mW
Output	Collector-Emitter voltage	V_{CEO}	80	V
	Emitter-Collector voltage	V_{ECO}	5	V
	Collector current	I_C	50	mA
	Collector power dissipation	P_C	150	mW
Total power dissipation		P_{tot}	170	mW
Isolation voltage 1 minute		V_{iso}	3750	Vrms
Operating temperature		T_{opr}	-55 to +115	°C
Storage temperature		T_{stg}	-55 to +125	°C
Soldering temperature 10 seconds		T_{sol}	260	°C

● Electro-optical Characteristics

(Ta=25°C)

Parameter		Symbol	Conditions	Min.	Typ.	Max.	Unit
Input	Forward voltage	V_F	$I_F = \pm 20\text{mA}$	-	1.2	1.4	V
	Terminal capacitance	C_t	$V=0, f=1\text{KHz}$	-	30	250	pF
Output	Collector dark current	I_{CEO}	$V_{CE}=20\text{V}, I_F=0$	-	-	0.1	uA
	Collector-Emitter breakdown voltage	BV_{CEO}	$I_C=100\text{uA}, I_F=0$	80	-	-	V
	Emitter-Collector breakdown voltage	BV_{ECO}	$I_E=100\text{uA}, I_F=0$	5	-	-	V
Transfer characteristics	Current transfer ratio	CTR	$I_F = \pm 1\text{mA}, V_{CE}=5\text{V}$	20	-	400	%
	Collector-Emitter saturation voltage	$V_{CE(sat)}$	$I_F = \pm 20\text{mA}, I_C=1\text{mA}$	-	0.1	0.3	V
	Isolation resistance	R_{iso}	DC500V 40 to 60%RH	5×10^{10}	10^{11}	-	Ω
	Floating capacitance	C_f	$V=0, f=1\text{MHz}$	-	0.6	1.0	pF
	Response time (Rise)	t_r	$V_{ce}=2\text{V}, I_C=2\text{mA}, R_L=100\Omega$	-	4	18	us
Response time (Fall)	t_f	-		3	18	us	

Classification table of current transfer ratio is shown below.

CTR Rank.	CTR (%)
KPC354NT0A	50 TO 150
KPC354NT0B	20 TO 400

Fig.1 Current Transfer Ratio vs. Forward Current

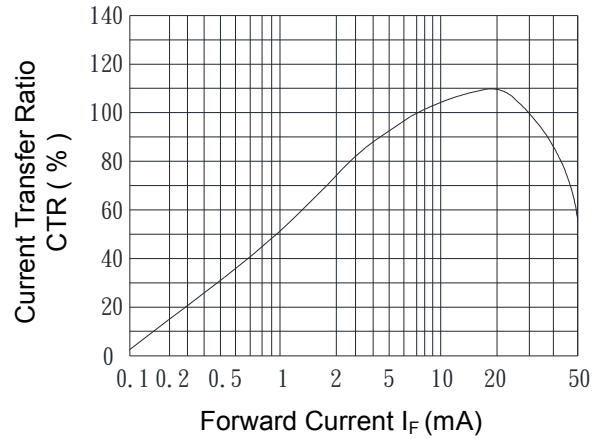

Fig.2 Collector Power Dissipation vs. Ambient Temperature

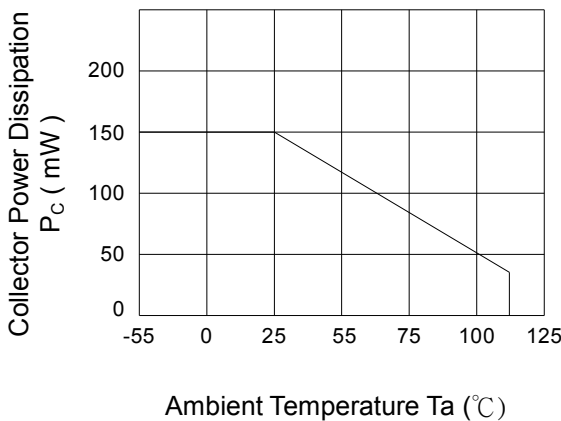

Fig.3 Collector Dark Current vs. Ambient Temperature

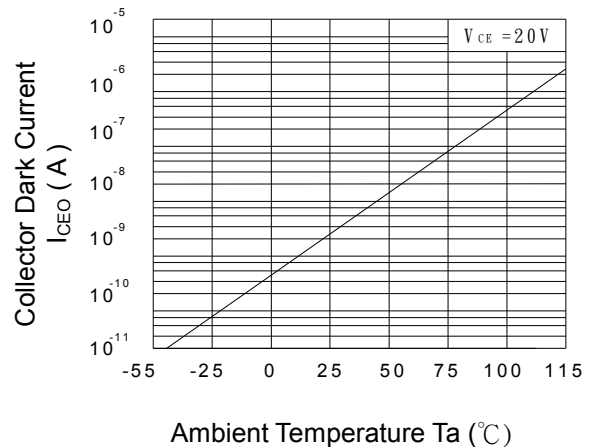

Fig.4 Forward Current vs. Ambient Temperature

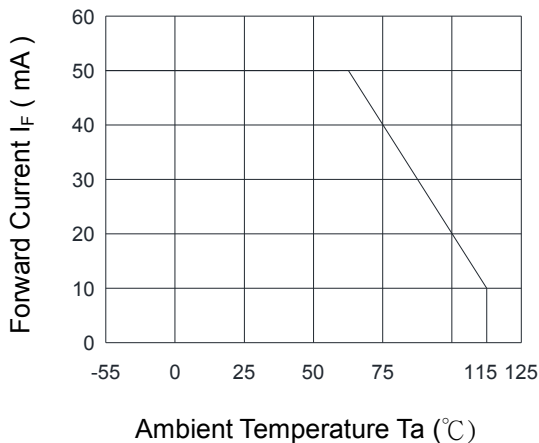

Fig.5 Forward Current vs. Forward Voltage

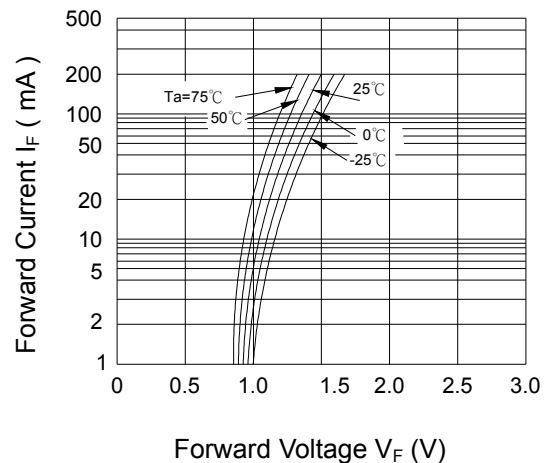

Fig.6 Collector Current vs. Collector-Emitter Voltage

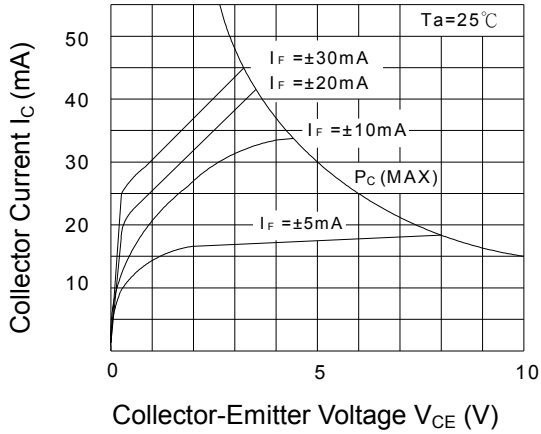

Fig.7 Relative Current Transfer Ratio vs. Ambient Temperature

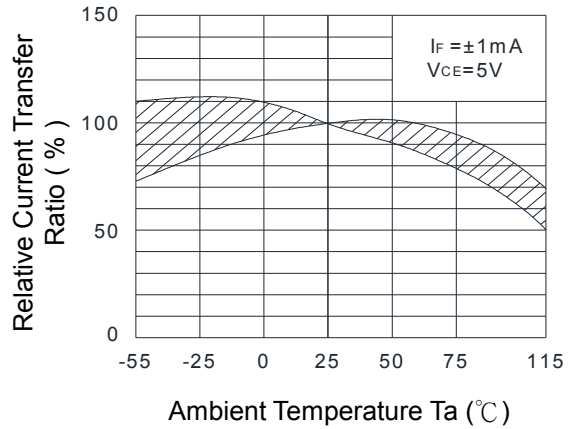

Fig.8 Collector-Emitter Saturation Voltage vs. Ambient Temperature

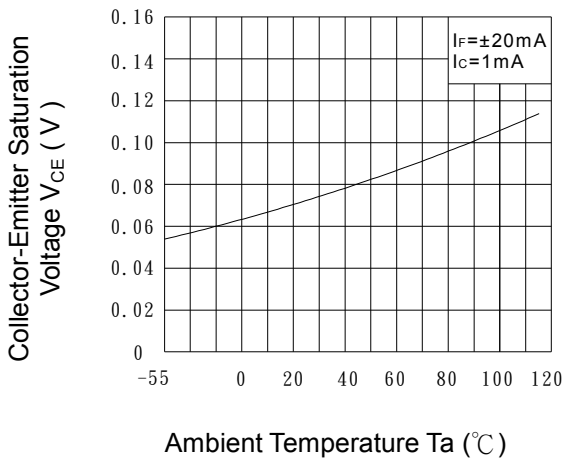

Fig.9 Collector-Emitter Saturation Voltage vs. Forward Current

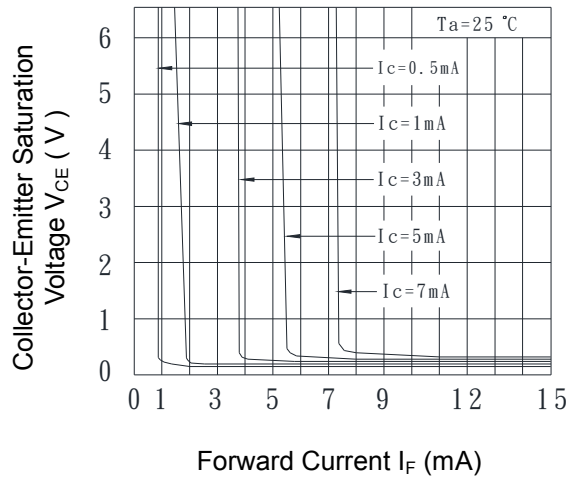

Fig.10 Response Time (Rise) vs. Load Resistance

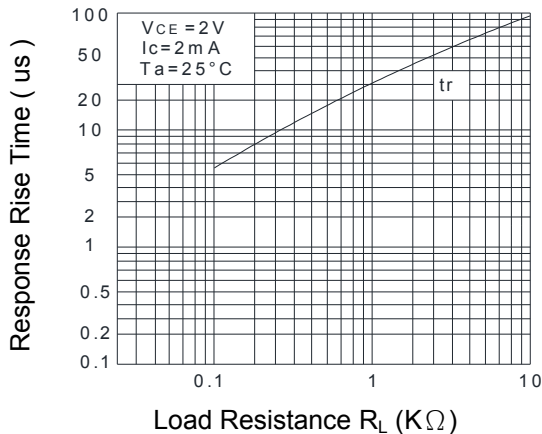
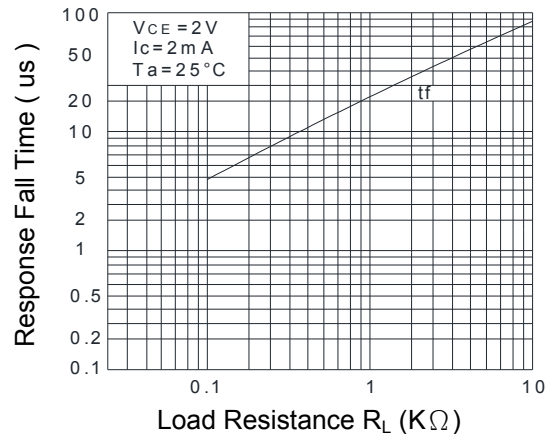
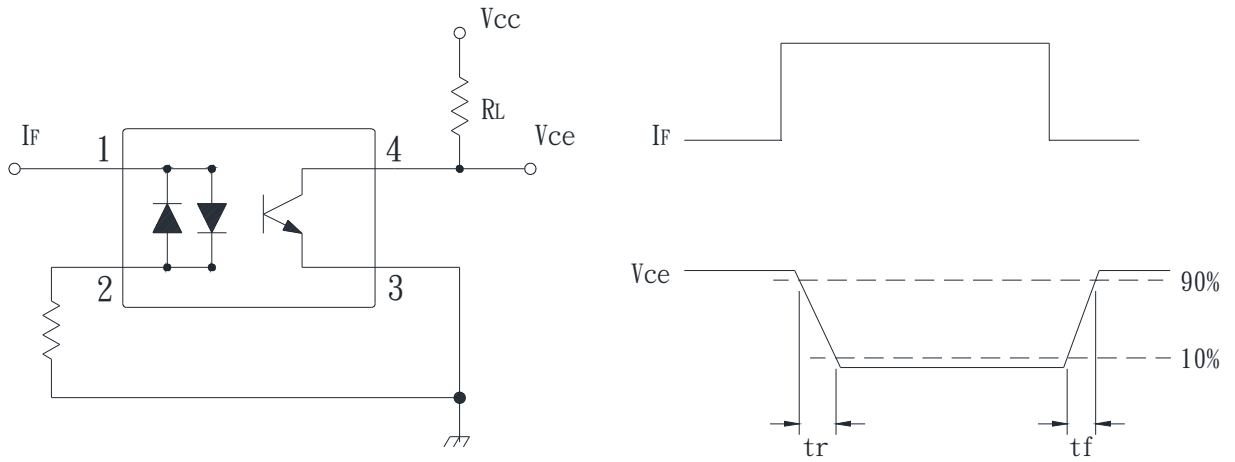

Fig.11 Response Time (Fall) vs. Load Resistance



● Test Circuit for Response Time



● **Recommended Soldering Conditions**

(a) **Infrared reflow soldering :**

- Peak reflow soldering : 260°C or below (package surface temperature)
- Time of peak reflow temperature : 10 sec
- Time of temperature higher than 230°C : 30-60 sec
- Time to preheat temperature from 180~190°C : 60-120 sec
- Time(s) of reflow : Two
- Flux : Rosin flux containing small amount of chlorine (The flux with a maximum chlorine content of 0.2 Wt% is recommended.)

Recommended Temperature Profile of Infrared Reflow

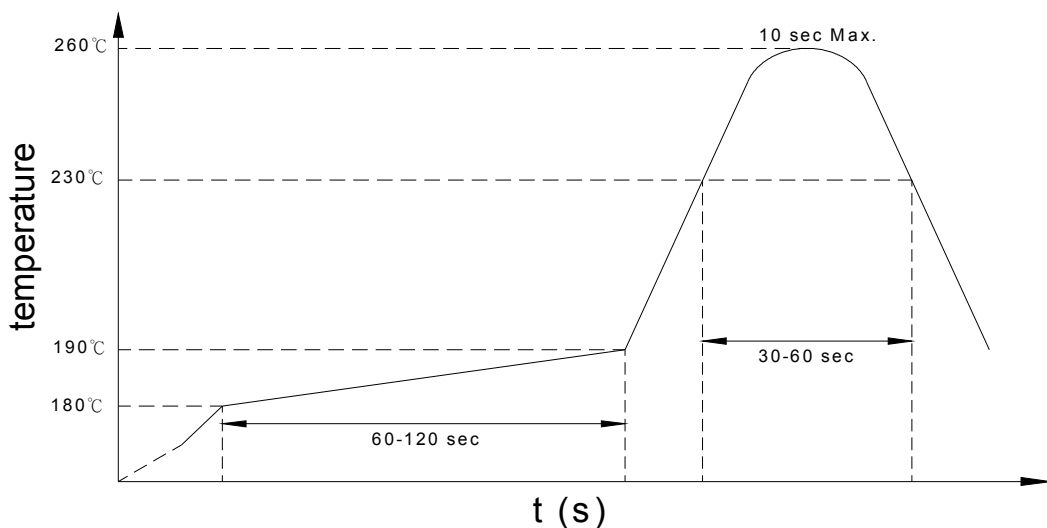

(b) **Wave soldering :**

- Temperature : 260°C or below (molten solder temperature)
- Time : 10 seconds or less
- Preheating conditions : 120°C or below (package surface temperature)
- Time(s) of reflow : One
- Flux : Rosin flux containing small amount of chlorine (The flux with a maximum chlorine content of 0.2 Wt% is recommended.)

(c) **Cautions :**

- Fluxes : Avoid removing the residual flux with freon-based and chlorine-based cleaning solvent.
- Avoid shorting between portion of frame and leads.

- **Numbering System**

KPC354NT Y (Z)

Notes:

KPC354NT = Part No.

Y = CTR rank option (A · B)

Z = Tape and reel option (TLD · TRU)

Option	Description	Packing quantity
TLD	TLD tape & reel option	3000 units per reel
TRU	TRU tape & reel option	3000 units per reel

- **Recommended Pad Layout for Surface Mount Lead Form**

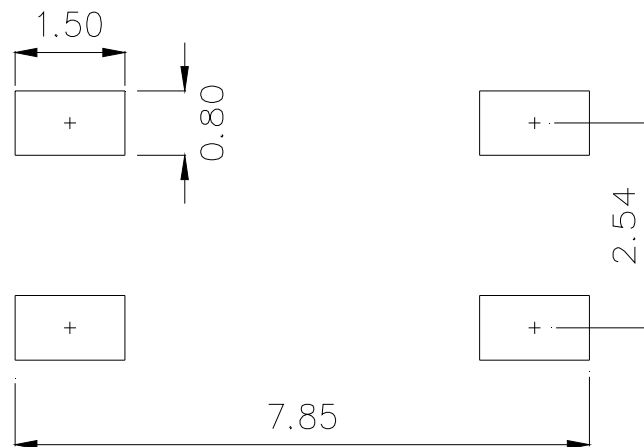
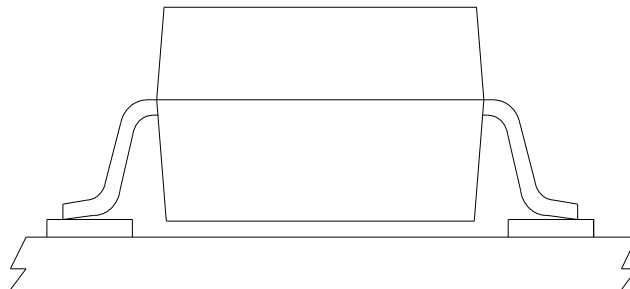

Unit : mm

● 4-pin Mini-Flat Carrier Tape & Reel

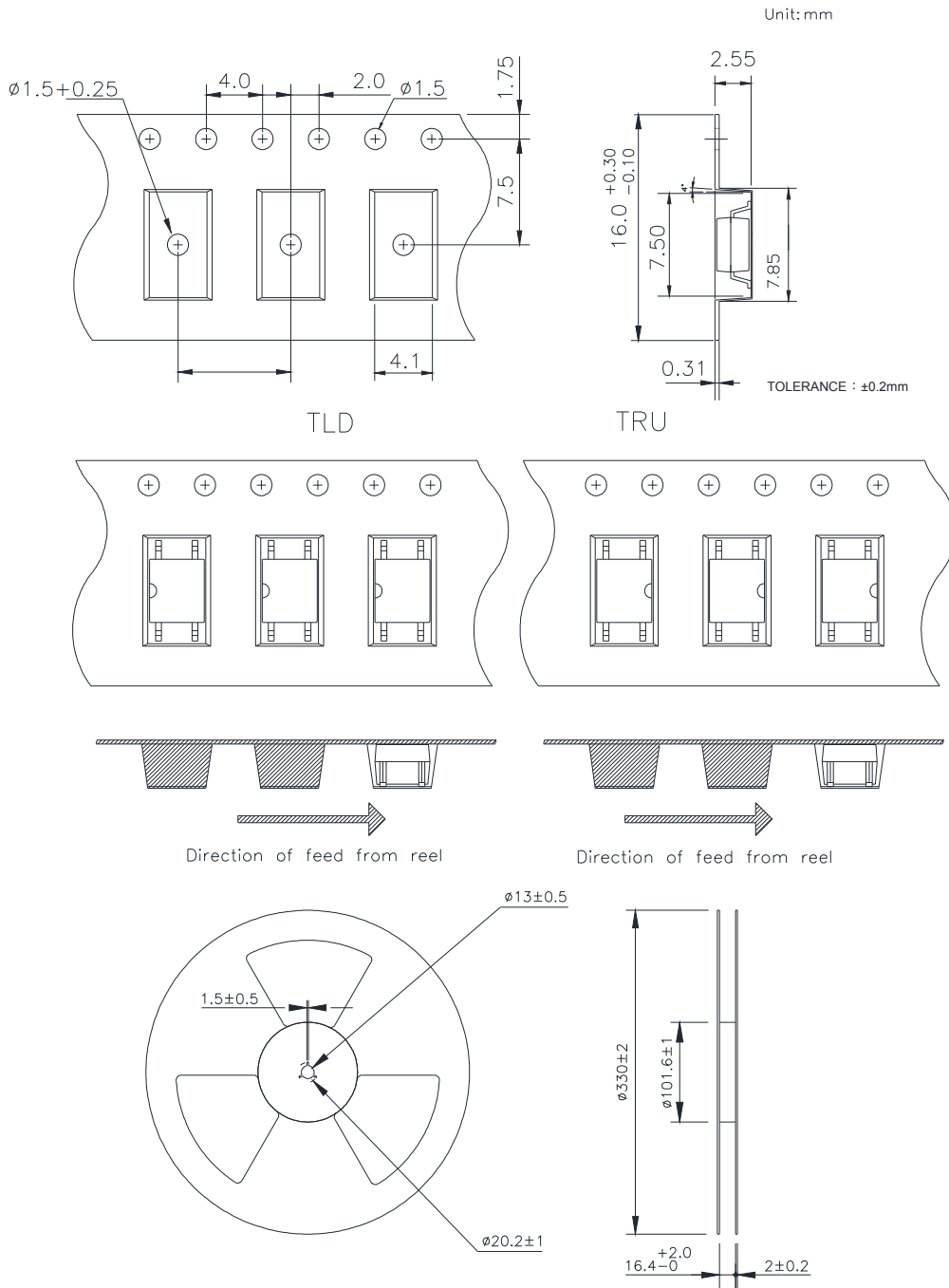



KPC354NT Series

4PIN MINI-FLAT PHOTOTRANSISTOR PHOTOCOUPLER

● Application Notice

The content of datasheet is the guidance for product use only. cosmo takes no responsibility to the accuracy of the information provided here. For continuously improving all of products, including quality, reliability, function...etc., cosmo reserves the right to change the specification, characteristics, data, materials, and structure of products without notice. Please contact with cosmo to obtain the latest specification.

It would be required to comply with the absolute maximum ratings listed in the specification. cosmo has no liability and responsibility to the damage caused by improper use of the products.

cosmo products are intended to be designed for use in general electronics application list below:

- a. Personal computer
- b. OA machine
- c. Audio / Video
- d. Instrumentation
- e. Electrical application
- f. Measurement equipment
- g. Consumer electronics
- h. Telecommunication

cosmo devices shall not be used or related with equipment requiring higher level of quality / reliability, or malfunction, or failure which may cause loss of human life, bodily injury, includes, without limitation:

- a. Medical and other life supporting equipments
- b. Space application
- c. Telecommunication equipment (trunk lines)
- d. Nuclear power control
- e. Equipment used for automotive vehicles, trains, ships...etc.

This publication is the property of cosmo. No part of this publication may be reproduced or copied in any form or any means electronically or mechanically for any purpose, in whole or in part without any written permission expressed from cosmo.